



# Snowdragon Industrial Co.,Ltd

## DATA SHEET

MODEL No : **SDL500FCD-0-XZ-D**

ENG. No:

Description:

- 5mm Round
- Lens Color: Water clear
- Emitting Color: Green
- No Stopper
- Viewing Angle :15°

DiceMaterial: InGaN

PREPARED BY	CHECKED BY	APPROVED BY
<b>CUSTOMER APPROVED SIGNATURES</b>		

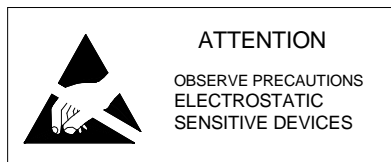

**Applications:**

**Dimension Drawing**

**Absolute Maximum Ratings at Ta = 25°C**

Items	Symbol	Absolute maximum Rating	Unit
Forward Current	I <sub>F</sub>	25	mA
Peak Forward Current*	I <sub>FP</sub>	100	mA
Reverse Voltage	V <sub>R</sub>	5	V
Power Dissipation	P <sub>D</sub>	100	mW
Operation Temperature	T <sub>opr</sub>	-20 ~ +75	°C
Storage Temperature	T <sub>stg</sub>	-30 ~ +80	°C
Lead Soldering Temperature	T <sub>sol</sub>	Max.260°C for 3 sec Max. (3mm from the base of the epoxy bulb)	

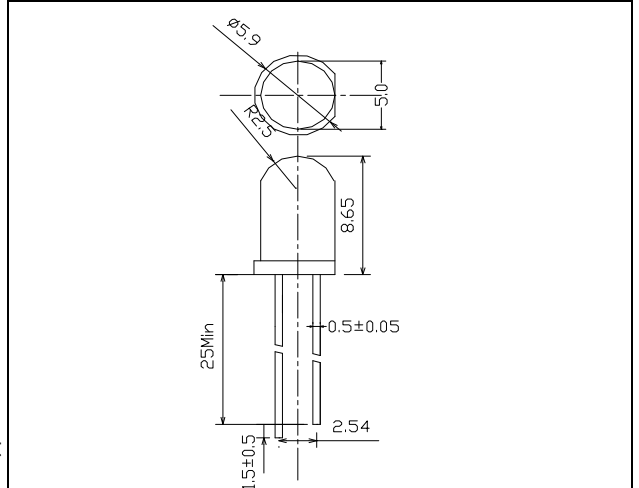

**Notes:**

1. All dimensions are in mm, Tolerance is ±0.25mm unless others noted
2. An epoxy meniscus may extend about 1.5mm
3. Burr around bottom of epoxy may be 0.5mm max.

\*pulse width <=0.1msec duty <=1/10

**Typical Electrical & Optical Characteristics ( Ta = 25°C)**

Items	Symbol	Condition	Min.	Typ.	Max.	Unit
Forward Voltage	V <sub>F</sub>	I <sub>F</sub> = 20mA	2.8	3.2	3.6	V
Reverse Current	I <sub>R</sub>	V <sub>R</sub> = 5V	---	---	10	μA
Wavelength	λ <sub>D</sub>	I <sub>F</sub> = 20mA	---	520	---	nm
Luminous Intensity	I <sub>v</sub>	I <sub>F</sub> = 20mA	---	27000	---	mcd
50% Power Angle	2θ <sub>1/2</sub> H-H	I <sub>F</sub> = 20mA	---	15	---	deg
	2θ <sub>1/2</sub> V-V	I <sub>F</sub> = 20mA	---	---	---	deg

  

Rank	Luminous Intensity(mcd)	Rank	Luminous Intensity(mcd)	Rank	Luminous Intensity(mcd)
/	/	/	/	/	/

**Important Notes:**

- 1) All ranks will be included per delivery, rank ratio will be determined by Snowdragon.
- 2) Tolerance of measurement of luminous intensity is ±15%.
- 3) Tolerance of measurement of dominant wavelength is ±1nm.
- 4) Tolerance of measurement of Vf is ±0.05 V.
- 5) Packaging methods are available for selection, please refer to PACKAGING STANDARD.
- 6) Please refer to LED LAMP RELIABILITY TEST STANDARD for reliability test conditions.

Typical Optical-Electronic Characteristic Curves

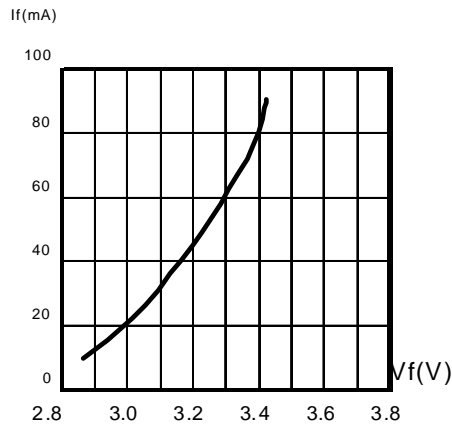

**Fig.1 FORWARD CURRENT VS. FORWARD VOLTAGE.**

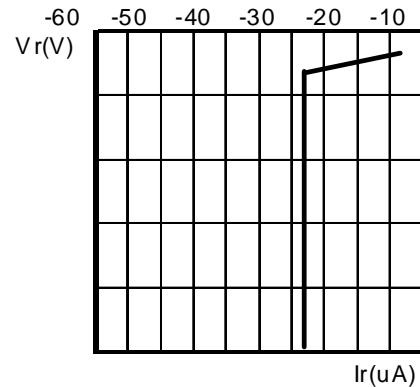

**Fig.2 REVERSE CURRENT VS. REVERSE VOLTAGE.**

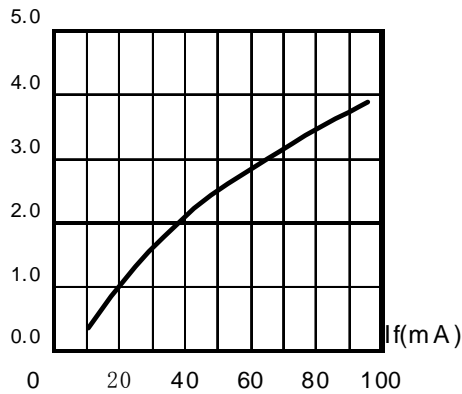

**Fig.3 RELATIVE LUMINOUS INTENSITY VS. FORWARD CURRENT.**

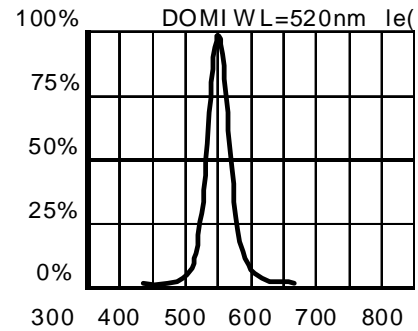

**Fig.4 RELATIVE LUMINOUS INTENSITY VS.WAVELENGTH.**

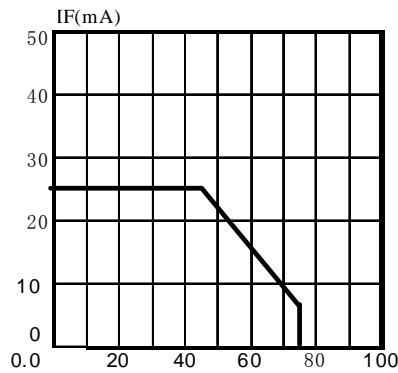

**FIG.5 MAXIMUM FORWARD DC CURRENT VS AMBIENT TEMPERATURE (Tjmax=105°C)**

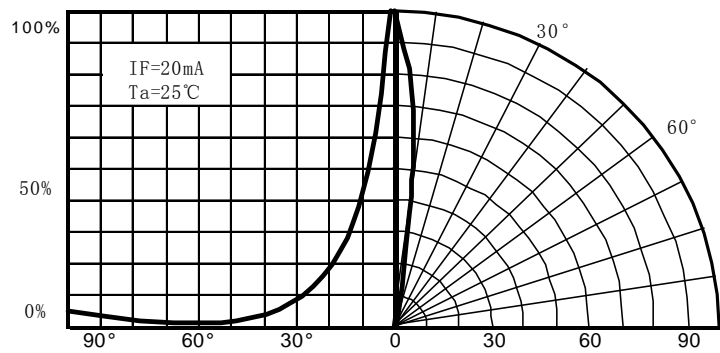

**Fig.6 FAR FIELD PATTERN**