



# Snowdragon Industrial Co.,Ltd

## DATA SHEET

MODEL No : **SDL534RCH-0-ES-L**

ENG. No: **09062005**

Description:

- 5mm Straw hat
- Lens Color: Water clear
- Emitting Color: Red
- No Stopper
- Viewing Angle :50°

DiceMaterial: AlGaInP

PREPARED BY	CHECKED BY	APPROVED BY
<b>CUSTOMER APPROVED SIGNATURES</b>		

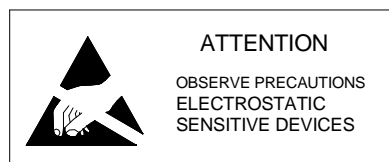

**Applications:**

**Dimension Drawing**

**Absolute Maximum Ratings at Ta = 25°C**

Items	Symbol	Absolute maximum Rating	Unit
Forward Current	$I_F$	25	mA
Peak Forward Current*	$I_{FP}$	100	mA
Reverse Voltage	$V_R$	5	V
Power Dissipation	$P_D$	100	mW
Operation Temperature	$T_{opr}$	-20 ~ +75	°C
Storage Temperature	$T_{stg}$	-30 ~ +80	°C
Lead Soldering Temperature	$T_{sol}$	Max.260°C for 3 sec Max. (3mm from the base of the epoxy bulb)	

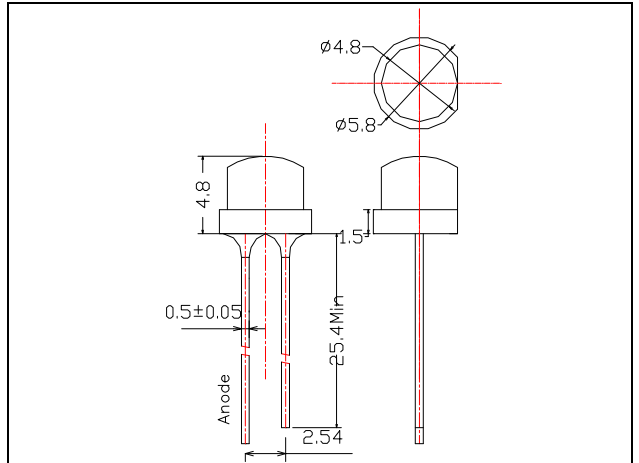

**Notes:**

1. All dimensions are in mm, Tolerance is  $\pm 0.25$ mm unless others noted
2. An epoxy meniscus may extend about 1.5mm
3. Burr around bottom of epoxy may be 0.5mm max.

\*pulse width  $\leq 0.1$ msec duty  $\leq 1/10$

**Typical Electrical & Optical Characteristics ( Ta = 25°C)**

Items	Symbol	Condition	Min.	Typ.	Max.	Unit
Forward Voltage	$V_F$	$I_F = 20$ mA	1.7	2.2	2.6	V
Reverse Current	$I_R$	$V_R = 5$ V	---	---	10	$\mu$ A
Wavelength	$\lambda_D$	$I_F = 20$ mA	---	625	---	nm
Luminous Intensity	$I_V$	$I_F = 20$ mA	---	1300	---	mcd
50% Power Angle	$2\theta_{\frac{1}{2}H-H}$	$I_F = 20$ mA	---	50	---	deg
	$2\theta_{\frac{1}{2}V-V}$	$I_F = 20$ mA	---	---	---	deg

Rank	Luminous Intensity(mcd)	Rank	Luminous Intensity(mcd)	Rank	Luminous Intensity(mcd)
/	/	/	/	/	/

**Important Notes:**

- 1) All ranks will be included per delivery, rank ratio will be determined by Snowdragon.
- 2) Tolerance of measurement of luminous intensity is  $\pm 15\%$ .
- 3) Tolerance of measurement of dominant wavelength is  $\pm 1$ nm.
- 4) Tolerance of measurement of  $V_f$  is  $\pm 0.05$  V.
- 5) Packaging methods are available for selection, please refer to PACKAGING STANDARD.
- 6) Please refer to LED LAMP RELIABILITY TEST STANDARD for reliability test conditions.

Typical Optical-Electronic Characteristic Curves

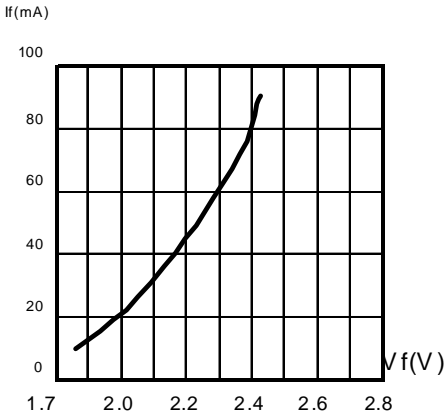

**Fig.1 FORWARD CURRENT VS. FORWARD VOLTAGE.**

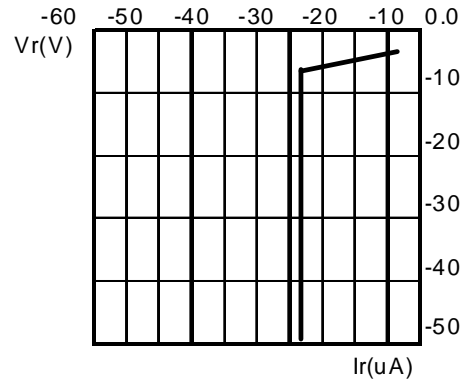

**Fig.2 REVERSE CURRENT VS. REVERSE VOLTAGE.**

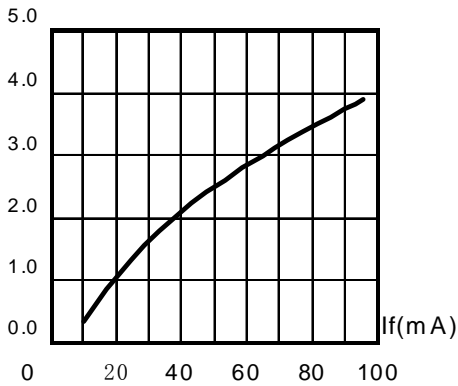

**Fig.3 RELATIVE LUMINOUS INTENSITY VS. FORWARD CURRENT.**

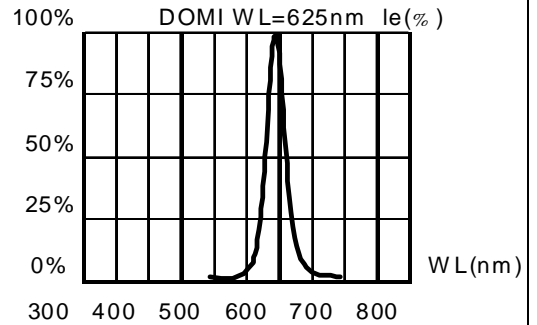

**Fig.4 RELATIVE LUMINOUS INTENSITY VS. WAVELENGTH.**

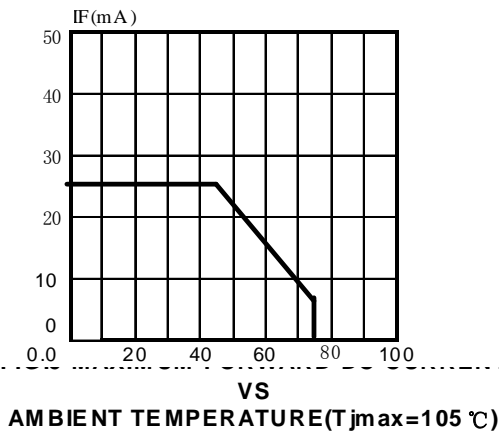

**VS AMBIENT TEMPERATURE (Tjmax=105 °C)**

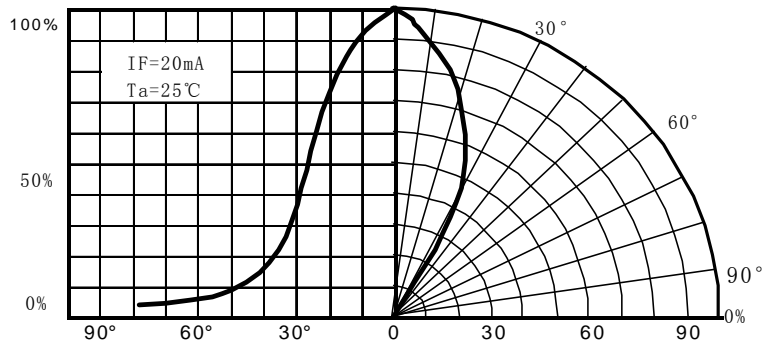

**Fig.6 FAR FIELD PATTERN**