

How to cut led strip

SMD5050 Flexible strip

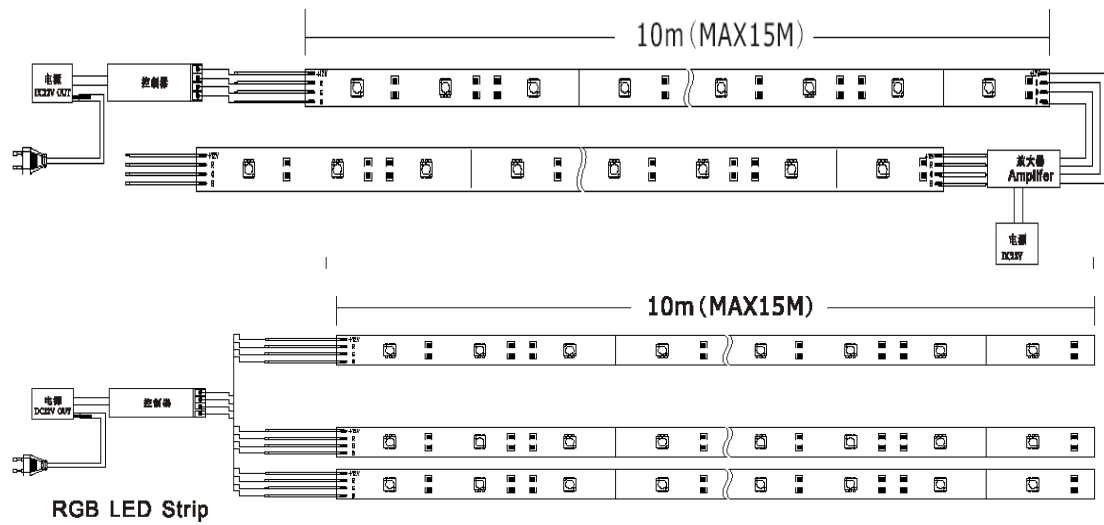

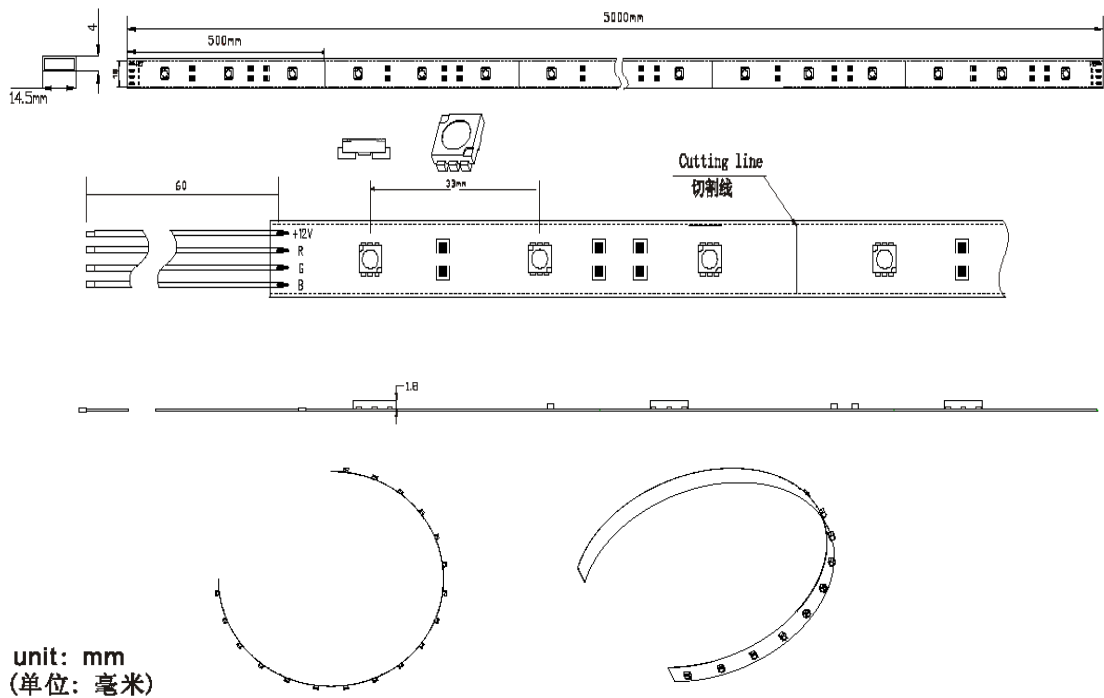
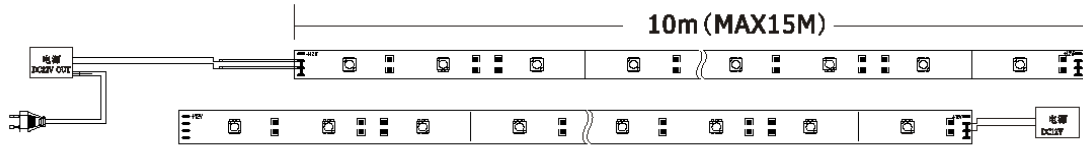

Single color LED Strip

SMD5050 Flexible strip with hollow silicon tube

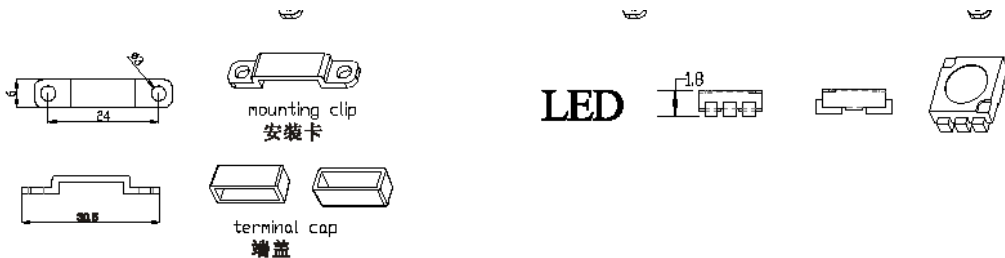
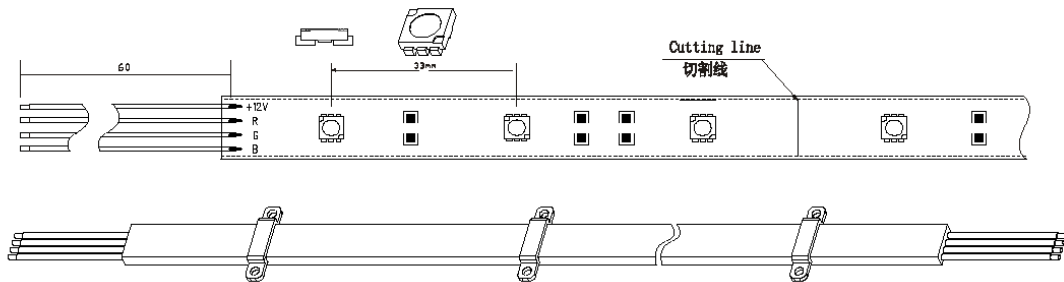
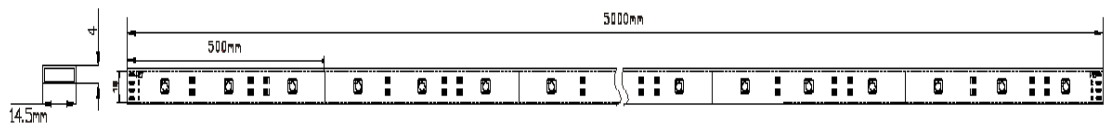
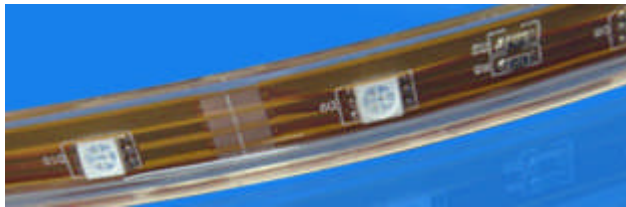

· DC12V+
Red color LED DC12V-
Green color LED DC12V-
Blue color LED DC12V-

unit: mm

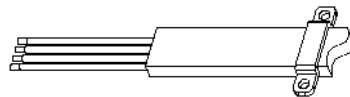

How to cut!
如何切割!

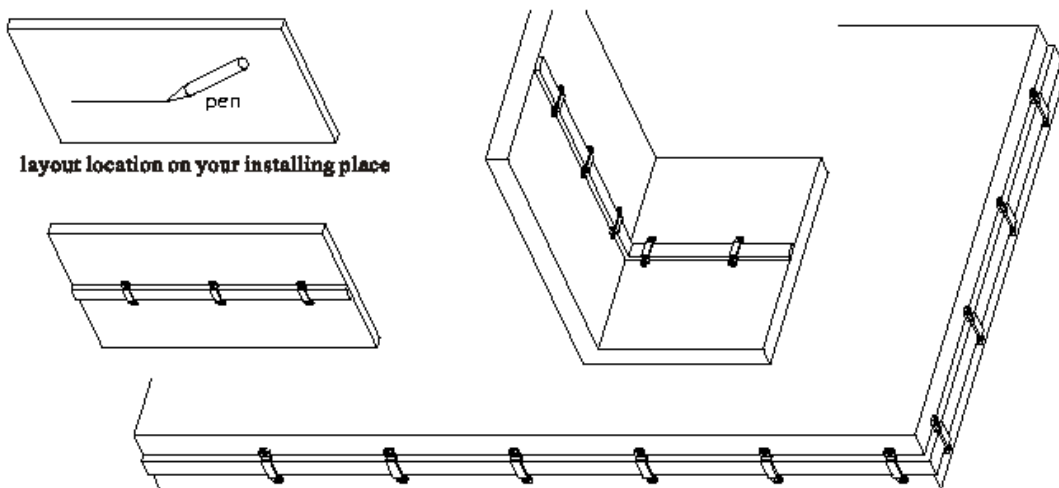
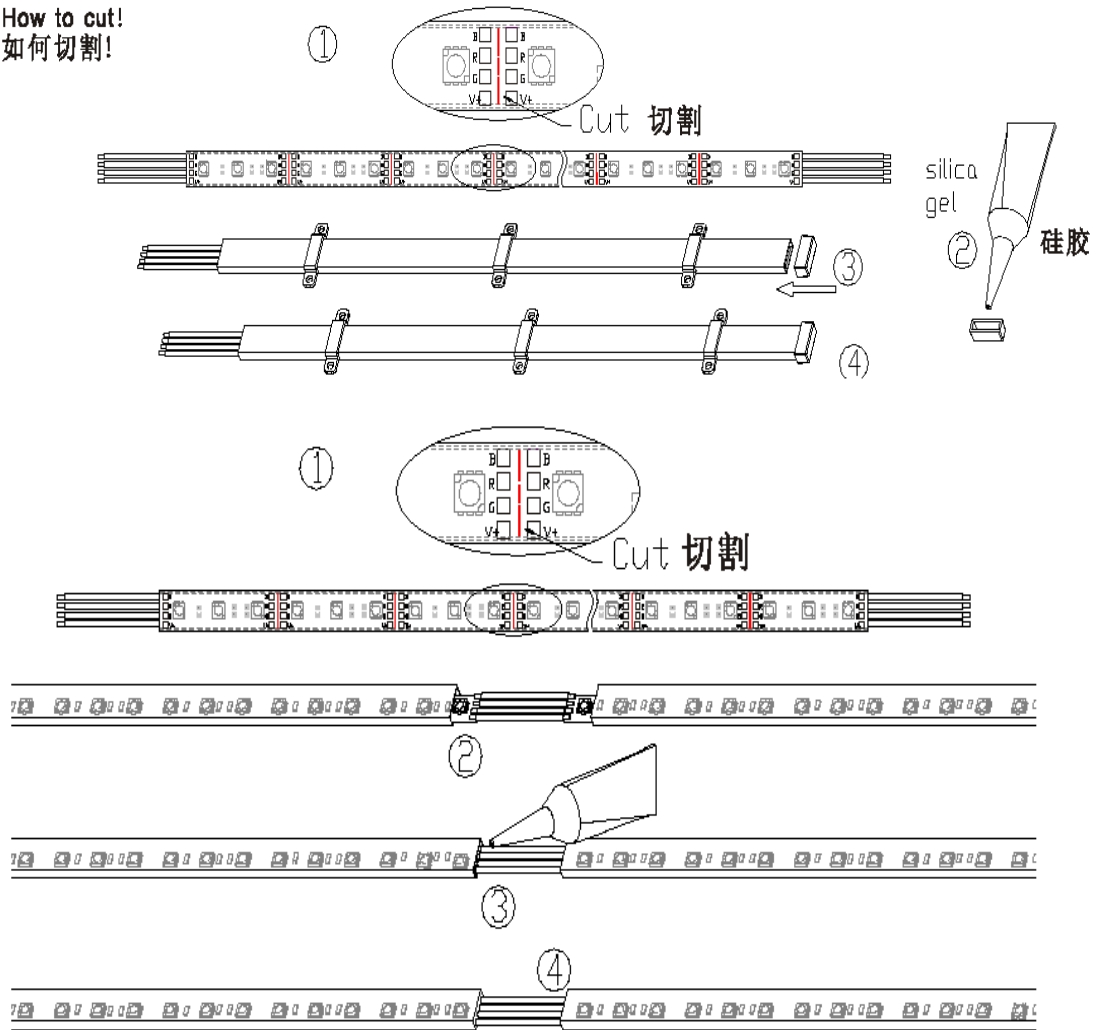

- 1) Layout location on installing place
- 2) Fix LED strip on the installing object by mounting clips
- 3) Have silicon in the end for waterproof
- 4) Connect the power supply

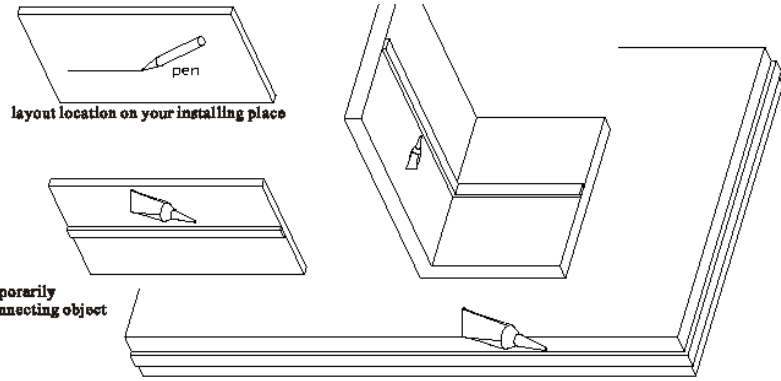

- 1) Layout location on installing place
- 2) Fix LED strip on the installing object temporarily
- 3) Have silicon on the two side of FPC for connecting object
- 4) Have silicon in the end for waterproof
- 5) Connect the power supply

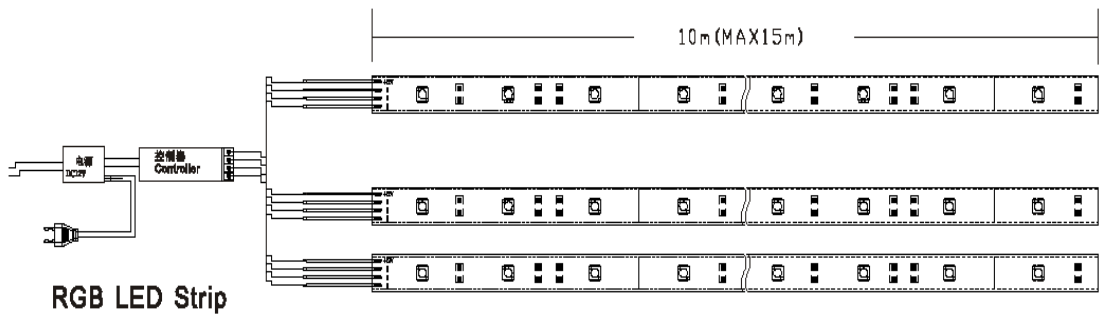
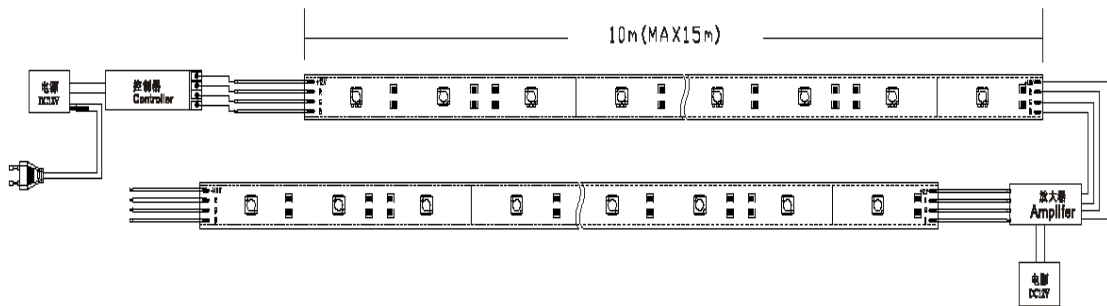

RGB LED Strip

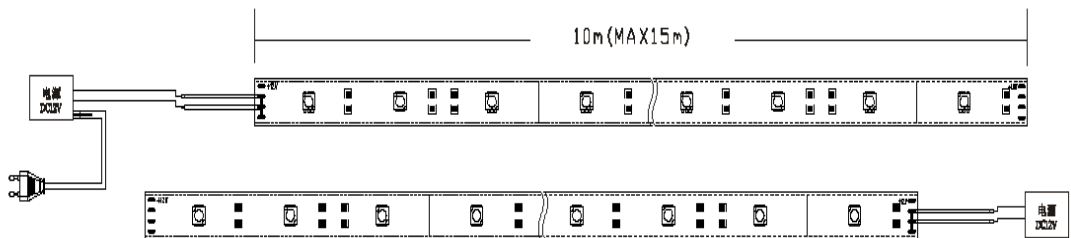

Single color LED Strip