



Snowdragon Industrial Co.,Ltd

DATA SHEET

MODEL No : **SDP234WCU-0-CM-C**

ENG. No: **09052303**

Description:

- 234 Square
- Lens Color: Water clear
- Emitting Color: White
- No Stopper
- Viewing Angle :120°

DiceMaterial: InGaN

PREPARED BY	CHECKED BY	APPROVED BY
CUSTOMER APPROVED SIGNATURES		

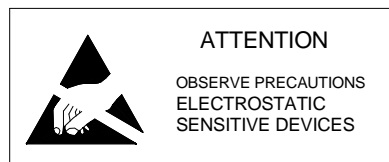

Applications:

Dimension Drawing

Absolute Maximum Ratings at Ta = 25°C

Items	Symbol	Absolute maximum Rating	Unit
Forward Current	I _F	25	mA
Peak Forward Current*	I _{FP}	100	mA
Reverse Voltage	V _R	5	V
Power Dissipation	P _D	100	mW
Operation Temperature	T _{opr}	-20 ~ +75	°C
Storage Temperature	T _{stg}	-30 ~ +80	°C
Lead Soldering Temperature	T _{sol}	Max.260°C for 3 sec Max. (3mm from the base of the epoxy bulb)	

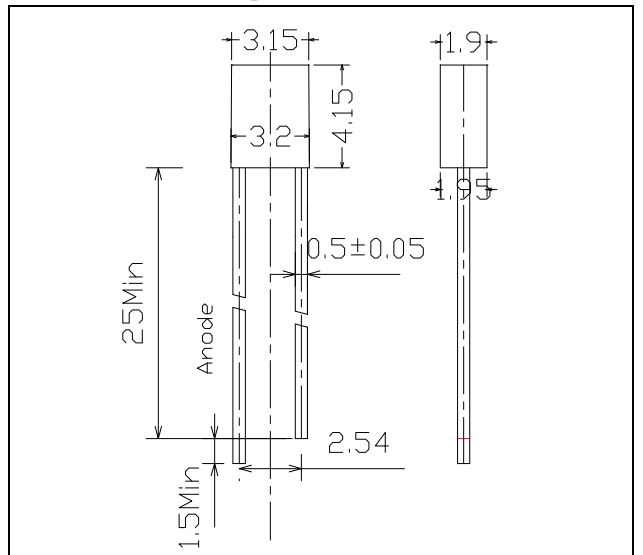

Notes:

1. All dimensions are in mm, Tolerance is ±0.25mm unless others noted
2. An epoxy meniscus may extend about 1.5mm
3. Burr around bottom of epoxy may be 0.5mm max.

*pulse width ≤ 0.1msec duty ≤ 1/10

Typical Electrical & Optical Characteristics (Ta = 25°C)

Items	Symbol	Condition	Min.	Typ.	Max.	Unit
Forward Voltage	V _F	I _F = 20mA	2.8	3.3	4.0	V
Reverse Current	I _R	V _R = 5V	---	---	10	μA
Wavelength	CCT	I _F = 20mA	---	8000	---	k
Luminous Intensity	I _v	I _F = 20mA	---	110	---	mcd
50% Power Angle	2θ _{1/2} H-H	I _F = 20mA	---	120	---	deg
	2θ _{1/2} V-V	I _F = 20mA	---	---	---	deg
Rank	Luminous Intensity(mcd)	Rank	Luminous Intensity(mcd)	Rank	Luminous Intensity(mcd)	
/	/	/	/	/	/	

Important Notes:

- 1) All ranks will be included per delivery, rank ratio will be determined by Snowdragon.
- 2) Tolerance of measurement of luminous intensity is ±15%.
- 3) Tolerance of measurement of dominant wavelength is ±1nm.
- 4) Tolerance of measurement of Vf is ±0.05 V.
- 5) Packaging methods are available for selection, please refer to PACKAGING STANDARD.
- 6) Please refer to LED LAMP RELIABILITY TEST STANDARD for reliability test conditions.

Typical Optical-Electronic Characteristic Curves

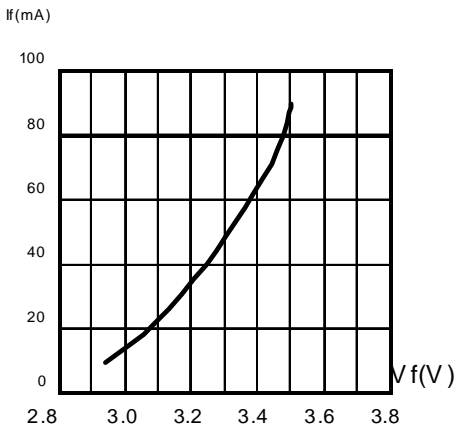

Fig.1 FORWARD CURRENT VS. FORWARD VOLTAGE.

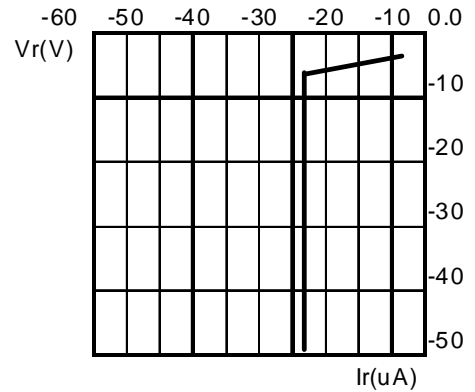

Fig.2 REVERSE CURRENT VS. REVERSE VOLTAGE.

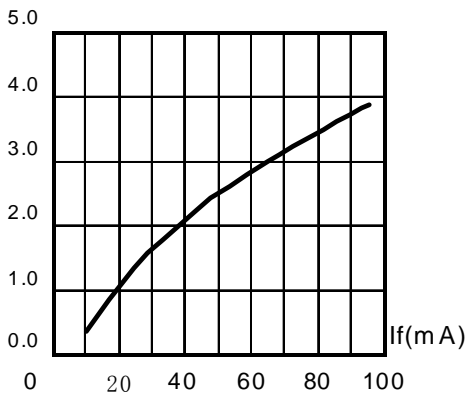

Fig.3 RELATIVE LUMINOUS INTENSITY VS. FORWARD CURRENT.

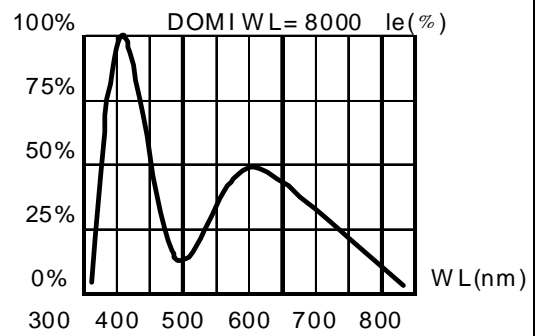

Fig.4 RELATIVE LUMINOUS INTENSITY VS. WAVELENGTH.

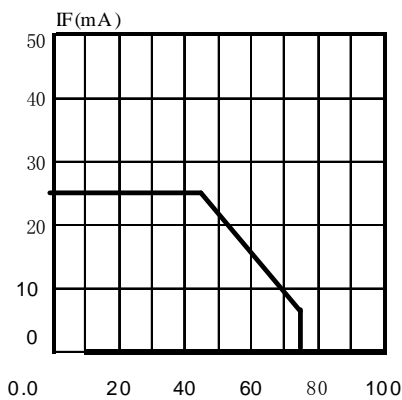

FIG.5 MAXIMUM FORWARD DC CURRENT VS AMBIENT TEMPERATURE (Tjmax=105°C)

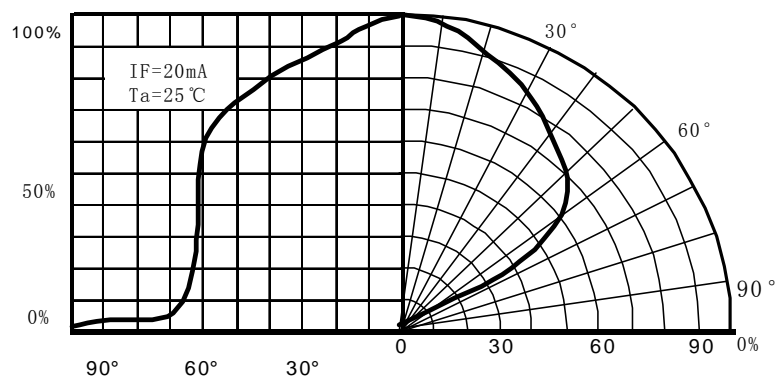

Fig.6 FAR FIELD PATTERN